

⚠ CAUTION

This product was designed to be installed on wood stud walls and solid concrete walls. Before installing make sure the supporting surface will support the combined load of the equipment and hardware. Never exceed the Maximum Load Capacity. This product is intended for indoor use only. Use of this product outdoors could lead to product failure or personal injury.

⚠ AVVERTENZA

Questo prodotto è stato progettato per essere installato su pareti di legno o muri in calcestruzzo. Prima dell'installazione assicurarsi che la superficie di appoggio sostenga il carico combinato dell'apparecchio più il supporto. Non superare mai la massima capacità di carico. Questo prodotto è destinato solo per uso interno.

⚠ AVERTISSEMENT

Ce produit est conçu pour être installé sur les murs de bois ou les murs en béton. Avant l'installation, assurez-vous que la surface d'appui pour soutenir la charge combinée de l'équipement de plus de soutien. Ne dépassez jamais la capacité de charge maximale. Ce produit est destiné à un usage interne.

⚠ WARNUNG

Dieses Produkt wurde entwickelt, um an den Wänden aus Holz oder Beton eingebaut werden. Vor der Installation sicherstellen, dass die Auflagefläche für die kombinierte Last der Ausrüstung plus zu unterstützen. Überschreiten Sie keinesfalls die maximale Belastbarkeit. Dieses Produkt ist für den internen Gebrauch bestimmt.

⚠ ADVERTENCIA

Este producto está diseñado para ser instalado en las paredes de madera o paredes de hormigón. Antes de la instalación, asegúrese de que la superficie de apoyo para soportar la carga combinada del equipo, más apoyo. Nunca exceda la capacidad máxima de carga. Este producto está diseñado sólo para uso interno.

⚠ AVISO

Este produto é projetado para ser instalado em paredes de madeira ou de paredes de concreto. Antes da instalação, certifique-se que a superfície de apoio para suportar a carga combinada do equipamento, além de apoio. Nunca exceda a capacidade máxima de carga. Este produto é destinado apenas para uso interno.

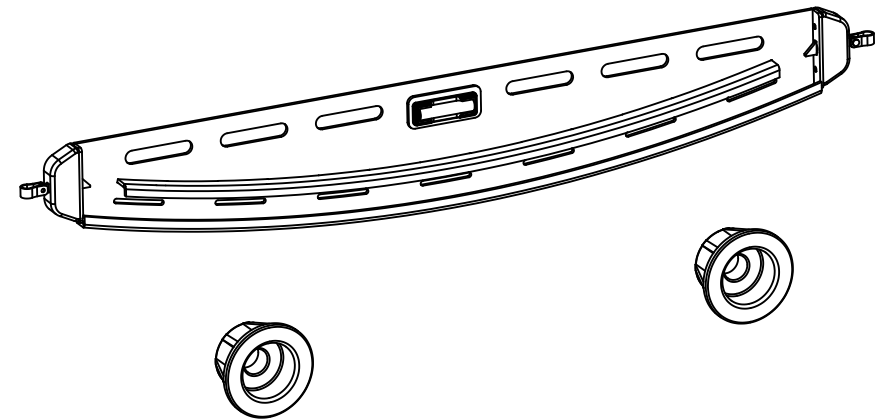

SCB-2542



SCB-2542

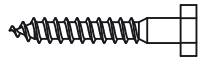

(A) Self-tap screws(4)



(B) Plastic anchors(4)

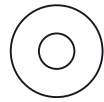

(C) Ø8 Flat washer(4)



(D) Ø5*Ø16*1.5 washer(4)



(E) M4*15 Screw(4)



(F) M5*15 Screw(4)

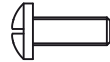

(G) M6*15 Screw(4)

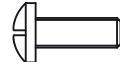

(H) M8*15 Screw(4)



Wall Plate(1)



Round pad(2)



Pull bar(1)



Round wheel(2)

STEP-1

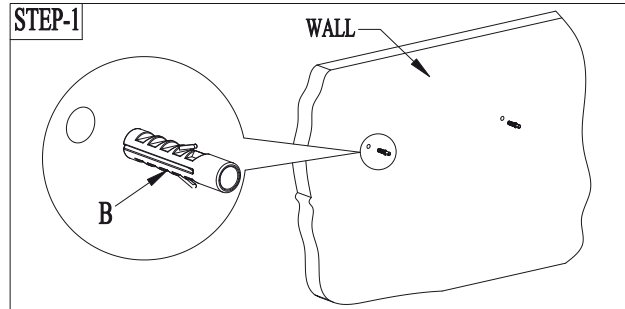

STEP-2

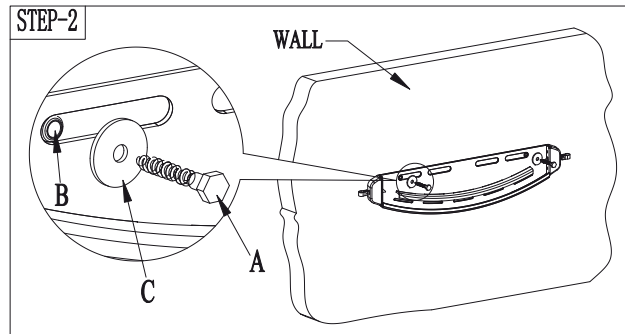

STEP-3

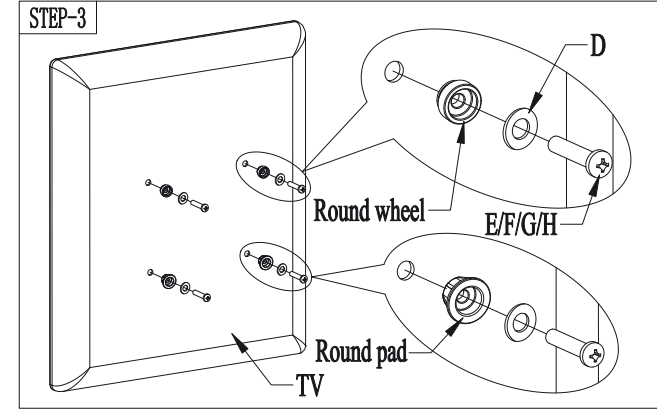

STEP-4

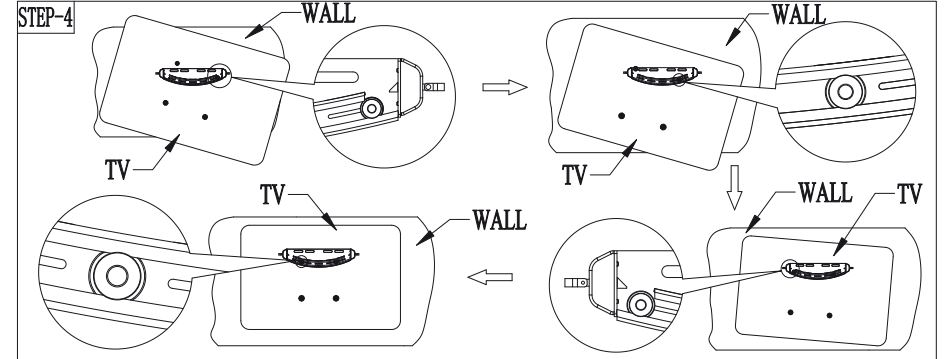

STEP-5

